



ISO 9001 by L.R.
PED DIR. 2014/68/UE by L.R.
ATEX DIR. 2014/34/UE by B.V.
FIRE SAFE EXECUTION BS6755/API 607 by L.R.
FIRE SAFE TESTED ISO 10497 by L.R.
ISO 15848 by TÜV
ANTISTATIC DEVICE by L.R.
EAC CERTIFICATION by B.V.

TYPE
FA2
PN 10 ÷ 40
ANSI 150 ÷ 300

NORME E DIRETTIVE APPLICATE DISPONIBILI AL SEGUENTE LINK:
STANDARD AND DIRECTIVE APPLIED AVAILABLE AT FOLLOWING LINK:
http://www.adlerspa.com/pdf/NORME_ADLER.pdf

VALVOLE A SFERA "CORPO PIATTO" SPLIT BODY PASSAGGIO TOTALE

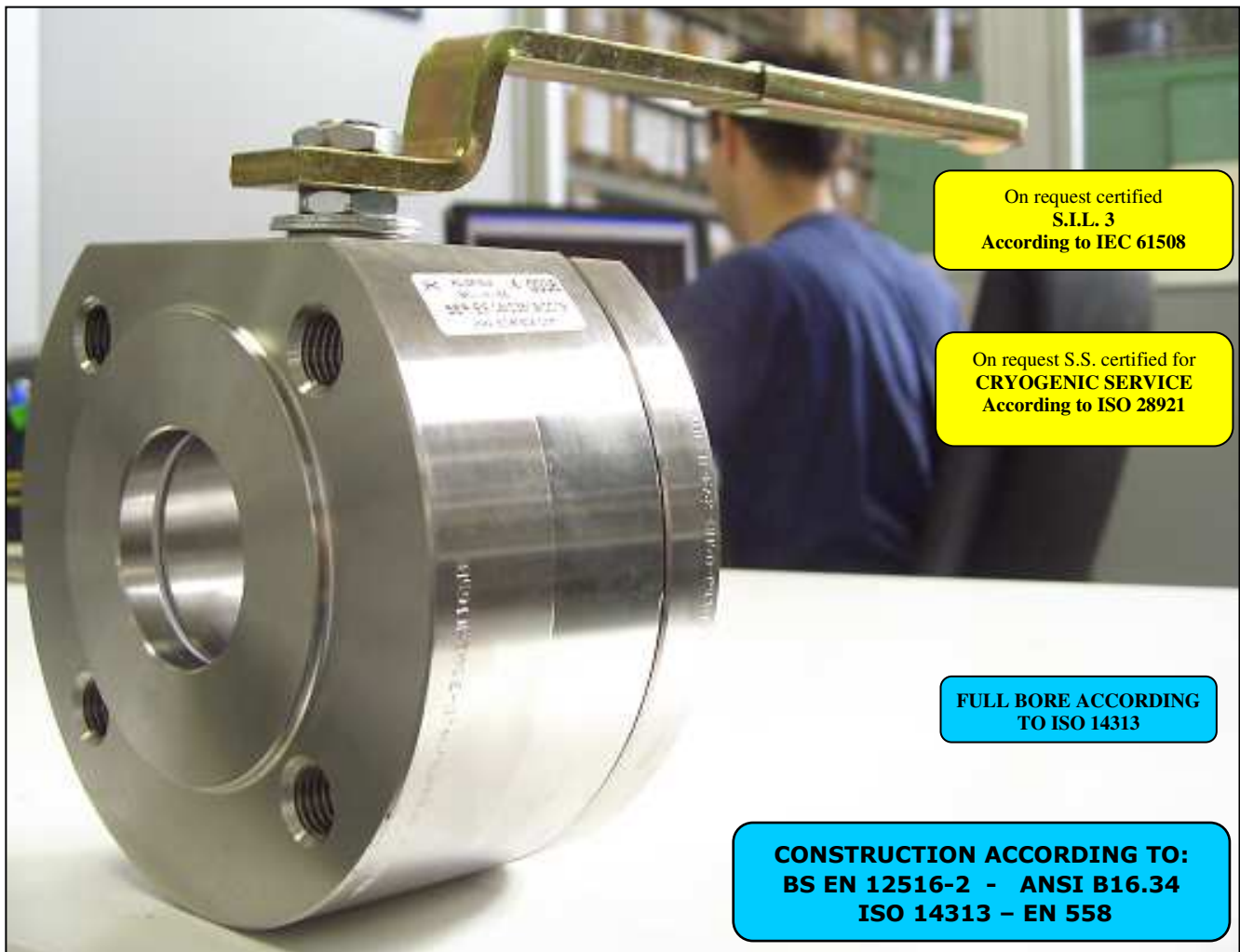

On request certified
S.I.L. 3
According to IEC 61508

On request S.S. certified for
CRYOGENIC SERVICE
According to ISO 28921

FULL BORE ACCORDING
TO ISO 14313

CONSTRUCTION ACCORDING TO:
BS EN 12516-2 - ANSI B16.34
ISO 14313 - EN 558

BALL VALVES
"WAFER TYPE" FULL BORE SPLIT BODY
ROBINETS A BOISSEAU SPHERIQUE
"WAFER" PASSAGE INTEGRAL 2 PIECES
FLANSCHKUGELHÄHNE IN "KOMPAKTBAUWEISE"
VOLLER DURCHGANG ZWEITEILIGES GEHÄUSE

WEB SITE: WWW.ADLERSPA.COM



ISO 9001 by L.R.
 PED DIR. 2014/68/UE by L.R.
 ATEX DIR. 2014/34/UE by B.V.
 FIRE SAFE EXECUTION BS6755/API 607 by L.R.
 FIRE SAFE TESTED ISO 10497 by L.R.
 ISO 15848 by TÜV
 ANTISTATIC DEVICE by L.R.
 EAC CERTIFICATION by B.V.

TYPE
FA2
 PN 10 ÷ 40
 ANSI 150 ÷ 300

VALVOLA A SFERA "CORPO PIATTO" SPLIT BODY PASSAGGIO TOTALE
 BALL VALVES "WAFER TYPE" SPLIT BODY FULL BORE
 ROBINETS A BOISSEAU SPHERIQUE "WAFER" PASSAGE INTEGRAL 2 PIECES
 FLANSCHKUGELHÄHNE IN "KOMPAKTBAUWEISE" VOLLER DURCHGANG ZWEITEILIGES GEHÄUSE

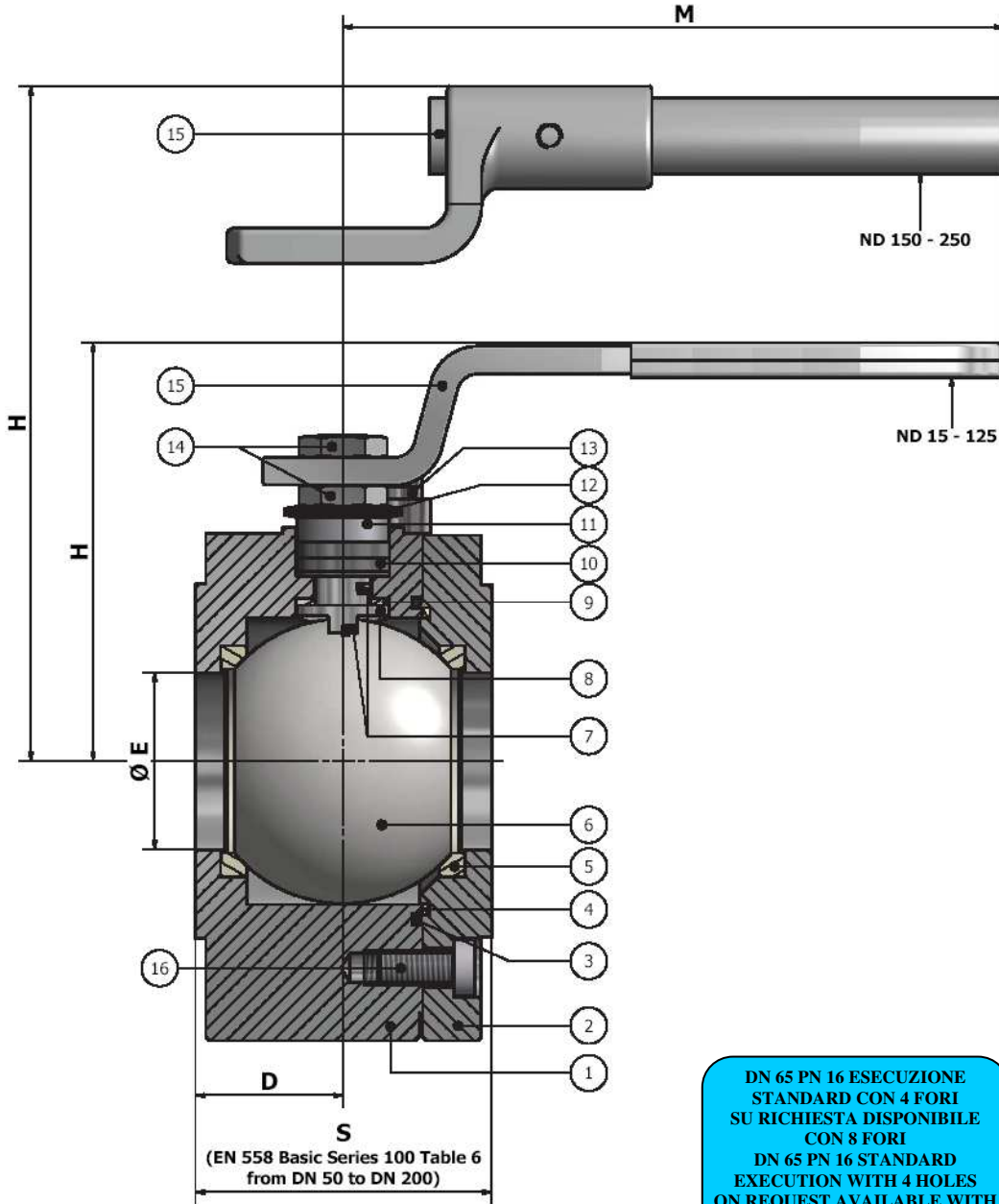

**VISUALIZZA 3D
 VIEW 3D**

<https://adlerspa.com/prodotti/fa2>

**FOR VALVES
 DN 200 ANSI 300
 QUOTE "S" = 335mm
 QUOTE "D" = 180,5mm**

DN 65 PN 16 ESECUZIONE
 STANDARD CON 4 FORI
 SU RICHIESTA DISPONIBILE
 CON 8 FORI
 DN 65 PN 16 STANDARD
 EXECUTION WITH 4 HOLES
 ON REQUEST AVAILABLE WITH
 8 HOLES

DN 200 ÷ 250
 -CONSIGLIATO
 RIDUTTORE MANUALE
 -MANUAL GEAR BOX
 SUGGESTED
 -REDUCTEUR MANUEL
 CONSEILLE
 -EMPFEHLEN WIR EIN
 HANDGETRIEBE
 SEE EXECUTION 5

ADLER BALL VALVES FA2/22 RIPRODUZIONE VIETATA - COPYRIGHT



ISO 9001 by L.R.
 PED DIR. 2014/68/UE by L.R.
 ATEX DIR. 2014/34/UE by B.V.
 FIRE SAFE EXECUTION BS6755/API 607 by L.R.
 FIRE SAFE TESTED ISO 10497 by L.R.
 ISO 15848 by TÜV
 ANTISTATIC DEVICE by L.R.
 EAC CERTIFICATION by B.V.

TYPE
FA2
 PN 10 ÷ 40
 ANSI 150 ÷ 300

N.	DESCRIZIONE DESCRIPTION DESCRIPTION BESCHREIBUNG	MATERIALI MATERIALS MATERIAUX WERKSTOFFE
1	CORPO BODY CORPS MITTE	ASTM A105 ASTM A479 304/304L ASTM A479 316/316L
2	GHIERA INSERT EMBOUT GEWINDEDRUCKRING	ASTM A105 ASTM A479 304/304L ASTM A479 316/316L
3*	O-RING	FKM - (VITON)
4*	ANELLO SEAL ANNEAU DICHTUNGSRING	P.T.F.E.
5*	SEDE SEAT SIEGE SITZRING	P.T.F.E. R.P.T.F.E. (OPTIONAL)
6	SFERA BALL BOULE KUGEL	ASTM A479 304/304L ASTM A351 CF8 ASTM A479 316/316L ASTM A351 CF8M
7	DISPOSITIVO ANTISTATICO ANTISTATIC DEVICE CONTACT ANTISTATIQUE ANTISTATIK VORRICHTUNG	ASTM A479 316/316L
8	STELO STEM TIGE SPINDEL	ASTM A479 304/304L ASTM A479 316/316L

N.	DESCRIZIONE DESCRIPTION DESCRIPTION BESCHREIBUNG	MATERIALI MATERIALS MATERIAUX WERKSTOFFE
9*	BUSSOLA STEM SEAL JOINT TIGE UNTERE SPINDELABDICHTUNG	P.T.F.E.
10*	PACCO A "V" CHEVRON RINGS JOINT A "V" 3 FACHE DACHMANSCHETTE	P.T.F.E. / GRAFITE P.T.F.E. / GRAPHITE P.T.F.E. / GRAPHITE P.T.F.E. / GRAPHIT
11	PREMIBUSSOLA PRESSING BUSH PRESSE RONDELLE STOPFBUCHSDRUCKRING	ASTM A479 304
12	MOLLE A TAZZA SPRING WASHERS RONDELLES BELLEVILLE TELLERFEDERN	C72/50Cr V4 ZINCATO - GALVANIZED - X10CrNi18.8 ZINGUE - VERZINKT ON REQUEST
13	VITE DI FERMO E FERMO PIN AND STOP PIN PLOINT ET PLOT D'ARRET ANSCHLAGBOLZEN	UNI3740 8.8 ZINCATO - GALVANIZED - UNI 3951 A2- ZINGUE - VERZINKT 70 ON REQUEST
14	DADO - CONTRODADO NUT - LOCK NUT ECROU - CONTRE-ECROU MUTTER - KONTERMUTTER	UNI 3740 - 6S ZINCATO - GALVANIZED - ASTM A479 ZINGUE - VERZINKT 304 ON REQUEST
15	LEVA WRENCH LEVIER HANDHEBEL	AISI 1010 CHROMED FOR S.S. VALVES ASTM A479 PAINTED FOR C.S. VALVES 304 ON REQUEST
16	VITE SCREW VIS SCHRAUBE	UNI 3740 8.8 ZINCATO - GALVANIZED - UNI 3951 ZINGUE - VERZINKT A2-70 ON REQUEST

* RICAMBI CONSIGLIATI - RECOMMENDED SPARE PARTS - PIECES DE RECHANGE CONSEILLEES - ERSATZTEIL EMPFEHLUNG

ON REQUEST P.T.F.E. AVAILABLE CERTIFIED BAM, FDA, MOCA

DIMENSIONI - DIMENSION - DIMENSIONS - ABMESSUNGEN

DN	15	20	25	32	40	50	65	80	100	125	150	200	250
A	10	10	12	12	16	16	22	22	30	30	42	48	56
B	6	6	8	8	10	10	14	14	18	18	28	32	36
C	7	7	10	10	10	10	12	12	17	17	19	20	20
D	17,5	17,5	21,5	25,5	32	S/2	S/2	S/2	S/2	S/2	S/2	S/2	S/2
E	15	19	25	30	38	51	64	76	101	118	152	203	254
F	M5	M5	M5	M5	M6	M6	M8	M8	M8	M10	M12	M16	M20
ISO	F03	F03	F03	F03	F05	F05	F07	F07	F07	F10	F12	F14	F16
G	25	25	25	25	35	35	55	55	55	70	85	100	130
H	66	68	85	91	110	120	144	152	174	188	256	294	343
L	33	33	36.5	41	52	62	79	88	105	133	152	228	257
M	145	145	185	185	280	280	370	370	470	650	750	900	1000
N	69	78	81	105	81	102	85	80	86	100	110	95	150
P	32,5	35	41	46,5	63	65	82	90.5	99.5	114	144	183	225,5
R	8	8	17	17	13	21	24	24	27	26	34	36	40
P			42,5		63	74,5	87	95	108	122,5	125	144	183
R			17		13	11	19	19	16	16	14	34	36
S	53	53	57	65	79	84	103	120	154	182	234	310	314*
T	36	36	36	36	50	50	70	70	70	102	125	140	165
~Kg	2,3	2,9	3,9	6,1	9,1	11,5	18	23,5	35	51	90	121	180

- DATI E CARATTERISTICHE SOGGETTI A VARIAZIONI SENZA PREAVVISO
- SPECIFICATIONS SUBJECT TO MODIFICATIONS WITHOUT PRIOR NOTICE
- TOUS DROITS DE MODIFICATION RESERVES
- KONSTRUKTIONÄNDERUNGEN VORBEHALTEN

DN 15÷40 OPTIONAL

PN 40

*Per PN 40 S = 340

ANSI 300

PN 10÷40 - ANSI 150



ADLER SpA - BALL VALVES
 20010 S. STEFANO TICINO (MI) ITALY V.le BORLETTI, 14 Tel. +39/02974842.11 FAX +39/0297271698
 E-mail: adler@adlerspa.com <http://www.adlerspa.com>



ISO 9001 by L.R.
 PED DIR. 2014/68/UE by L.R.
 ATEX DIR. 2014/34/UE by B.V.
 FIRE SAFE EXECUTION BS6755/API 607 by L.R.
 FIRE SAFE TESTED ISO 10497 by L.R.
 ISO 15848 by TÜV
 ANTISTATIC DEVICE by L.R.
 EAC CERTIFICATION by B.V.

TYPE
FA2
 PN 10 ÷ 40
 ANSI 150 ÷ 300

• ESECUZIONI • EXECUTIONS • EXECUTIONS • AUSFÜHRUNGEN



EXECUTION 4- 12

ONLY FOR VALVES \geq DN 50 **S**

FORO DI BILANCIAMENTO
 BALANCING HOLE
 TROU DE BALANCEMENT
 DRUCKENTLASTUNGSBOHRUNG

ON REQUEST AVAILABLE ON DN \leq 40



EXECUTION 6 - 16

S STANDARD

O OPTIONAL

1 **S**

-MONTAGGIO VITI – SCREW ASSEMBLING
 -MONTAGE VIS – EINBAU MIT SCHRAUBEN

2 **O**

-MONTAGGIO DI FONDO
 -END TANK ASSEMBLING
 -MONTAGE FOND DE CUVE
 -EINBAU ALS BODENABBLASSKUGELHAHN

3 **O**

-MONTAGGIO BULLONI
 -BOLTS ASSEMBLING
 -MONTAGE BOULONS
 EINBAU MIT ZUGBOLZEN

4 **S**

-STELO ANTI ESPULSIONE -ANTI BLOW OUT STEM
 -TIGE ANTIEXPULSION -AUSBLASGESICHERETE WELLE

-PACCO A "V" -CHEVRON RINGS
 -JOINT A "V" -3 FACHE DACHMANSCHETE
 ANTISTATIC DEVICE ANTISTATIK VORRICHTUNG
 BS 5146

C.N.C. TOOLING

6 **O**

BREVETTO – PATENTED
 00219688 - 21-04-1993

FKM (VITON)

-“O” RING STELO “O” RING ON STEM
 -TIGE AVEC “O” RING
 -“O” RING IM SPINDELBEREICH

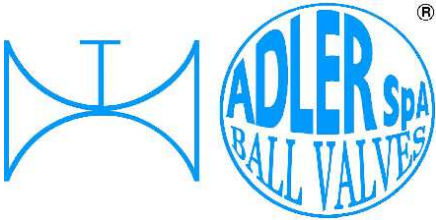

ISO 9001 by L.R.
 PED DIR. 2014/68/UE by L.R.
 ATEX DIR. 2014/34/UE by B.V.
 FIRE SAFE EXECUTION BS6755/API 607 by L.R.
 FIRE SAFE TESTED ISO 10497 by L.R.
 ISO 15848 by TÜV
 ANTISTATIC DEVICE by L.R.
 EAC CERTIFICATION by B.V.

TYPE
FA2
 PN 10 ÷ 40
 ANSI 150 ÷ 300

7

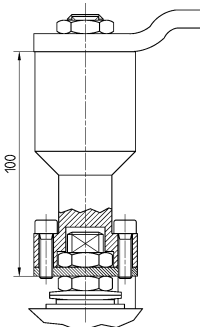

-PROLUNGA STELO -STEM EXTENSION
 -TIGE PROLONGEE -SPINDELVERLÄNGERUNG

8

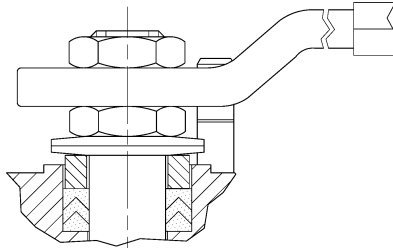

-PARTICOLARI INOX
 -STAINLESS STEEL DETAILS
 -ACCESSOIRES EN INOX
 -EDELSTAHLTEILE

9

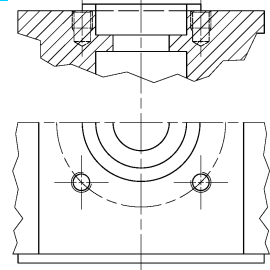

-ATTACCO "ISO" -"ISO" CONNECTIONS
 -SYSTEM "ISO" -ANSCHLUSS "ISO"

10

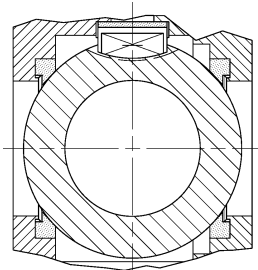

DN 15 ÷ 200
 -SFERA CONTENUTA -CONTENTS BALL
 -BOULE CONTENUE
 -NICHT RAUSRAGENDE KUGEL

11

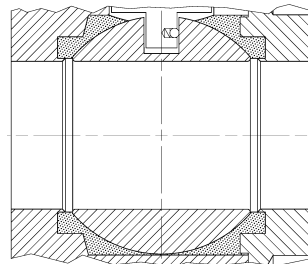

-TENUTE INTEGRALE -POCKETLESS SEATS
 -TENUE INTEGRALE -TOTRAUMARM
 -P.T.F.E. / R.T.F.E.

12

FIRE SAFE
 ISO 10497 "ISO-FT"
 (BS 6755 / API 607)



13

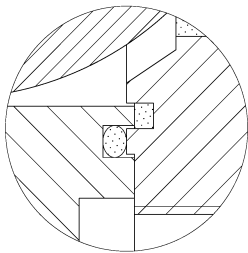

BREVETTO - PATENTED 00219619
 -DOPPIA TENUTA -DOUBLE SEALS
 -DOUBLE ETANCHEITE -DOPPELTE ABDICHTUNG
 -GHIERA A BATTUTA -METAL BEATING RING
 -EMBOUT AVEC BATTUE MECANIQUE
 -METALLISCHER ANSCHLAG DES
 GEWINDEDRUCKRINGS

14

VEDERE / SEE ANSI B16.34

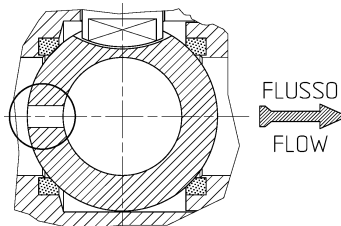

FLUSSO
 FLOW

-FORO DI SCARICO NELLA SFERA
 -OVERPRESSURE HOLE INTO BALL
 -TROU DECOMPRESSION DANS LA BOULE
 -ENTLASTUNGSBOHRUNG IN DER KUGEL
 VALVOLA MONO DIREZIONALE
 MONO-DIRECTIONAL VALVE

15

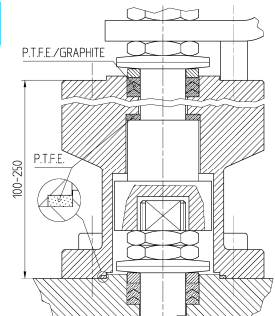

-SERVIZIO CRIOGENICO -CRYOGENIC SERVICE
 -SERVICE CRYOGENIQUE
 -TIEFTEMPORATUR SERVICE

16



-FIRE SAFE ISO FT+ "O" RING STELO
 -FIRE SAFE ISO FT+ "O" RING ON STEM
 -SECURITE FEU ISO FT+ TIGE AVEC "O" RING
 -FEUERSICHERE AUSFUHRUNG ISO FT+
 "O" RING IM SPINDELBEREICH

17

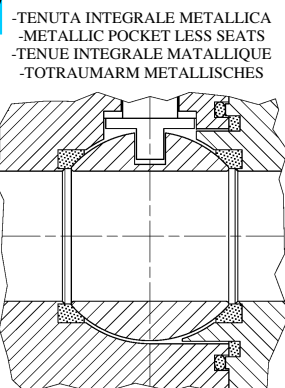

-TENUTA INTEGRALE METALLICA
 -METALLIC POCKET LESS SEATS
 -TENUE INTEGRALE MATALLIQUE
 -TOTRAUMARM METALLISCHES

18

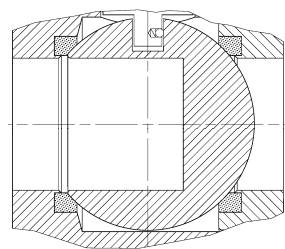

-SFERA CIECA PER CAMPIONATURA
 -BLIND BALL FOR SAMPLING
 -PRISE-ECHANTILLON
 KUGEL FÜR PROBEHAHME

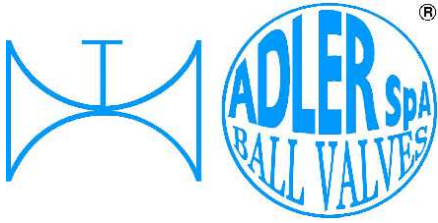

ISO 9001 by L.R.
 PED DIR. 2014/68/UE by L.R.
 ATEX DIR. 2014/34/UE by B.V.
 FIRE SAFE EXECUTION BS6755/API 607 by L.R.
 FIRE SAFE TESTED ISO 10497 by L.R.
 ISO 15848 by TÜV
 ANTISTATIC DEVICE by L.R.
 EAC CERTIFICATION by B.V.

TYPE
FA2
 PN 10 ÷ 40
 ANSI 150 ÷ 300

VITI D'ASSEMBLAGGIO PER FA2 - ASSEMBLING SCREWS FOR FA2 - VIS D'ASSEMBLAGE POUR FA2- MONTAGESCHRAUBEN FÜR FA2

N° VITI – DIMENSIONE • N° SCREW – DIMENSIONS • N° VIS- DIMENSIONS • N° SCHRAUBEN-ABMESSUNGEN

EUROPEAN NORM

DN PN	10-15		20		25		32		40		50		65		80		100		125		150		200		250			
10	8	M12 X30	8	M12 X30	8	M12 X30	8	M16 X35	8	M16 X35	8	M16 X40	8	M16 X40	16	M16 X40	16	M16 X40	16	M16 X45	16	M20 X45	16	M20 X50				
16	8	M12 X30	8	M12 X30	8	M12 X30	8	M16 X35	8	M16 X35	8	M16 X40	8	M16 X40	16	M16 X40	16	M16 X40	16	M16 X45	16	M20 X45	24	M20 X50	24	M24 X65		
25	8	M12 X30	8	M12 X35	8	M12 X35	8	M16 X40	8	M16 X45	8	M16 X40	16	M16 X45	16	M16 X45	16	M20 X50	16	M24 X55	16	M24 X55	24	M24 X60	24	M27 X80		
40	8	M12X30	8	M12 X35	8	M12 X35	8	M16 X40	8	M16 X45	8	M16 X40	16	M16 X45	16	M16 X45	16	M20 X50	16	M24 X55	16	M24 X55	24	M27 X65	24	M30 X80		

* N° 8 per UNI 2223/2229

ANSI METRIC

(STANDARD ADLER)

Ø Rating	1/2"		3/4"		1"		1 1/4"		1 1/2"		2"		2 1/2"		3"		4"		5"		6"		8"		10"			
150	8	M14 X30	8	M14 X30	8	M14 X30	8	M14 X35	8	M14 X35	8	M16 X40	8	M16 X40	8	M16 X45	16	M16 X45	16	M20 X50	16	M20 X50	16	M20 X50	24	M24 X70		
300	8	M14 X30	8	M16 X30	8	M16 X35	8	M16 X40	8	M20 X45	16	M16 X40	16	M20 X50	16	M20 X50	16	M20 X55	16	M20 X60	24	M20 X60	24	M24 X70				

ANSI B1.1 UNC

(ON REQUEST)

Ø Rating	1/2"		3/4"		1"		1 1/4"		1 1/2"		2"		2 1/2"		3"		4"		5"		6"		8"		10"	
150	8	1/2 X 1 1/4	8	1/2 X 1 1/4	8	1/2 X 1 1/4	8	1/2 X 1 1/4	8	5/8 X 1 1/2	8	5/8 X 1 1/2	8	5/8 X 1 3/4	8	5/8 X 1 3/4	16	5/8 X 1 3/4	16	3/4 X 2	16	3/4 X 2	16	3/4 X 2	24	7/8 X 2 3/4
300	8	1/2 X 1 1/4	8	5/8 X 1 1/4	8	5/8 X 1 1/2	8	5/8 X 1 1/2	8	3/4 X 1 3/4	16	5/8 X 1 3/4	16	3/4 X 2	16	3/4 X 2	16	3/4 X 2 1/4	16	3/4 X 2 1/2	24	3/4 X 2 1/2	24	7/8 X 2 3/4		

Length of screws calculated considering a gasket with thickness of 2mm.

