

# HIGH PERFORMANCE BUTTERFLY VALVE

Butterfly valve double offset design | type HG

## Advantages

Reliable sealing against high pressures and low torques due to the double offset design

Low-wear switching characteristics

Secure stem sealing (Option: TA-Luft)

Variable seat ring materials

GEFA-MULTITOP Efficient automation with variable interface without interruption of the stem

Pivoting angle limitation and optical position indicator at the stem prevents wrong position of the stem during servicing

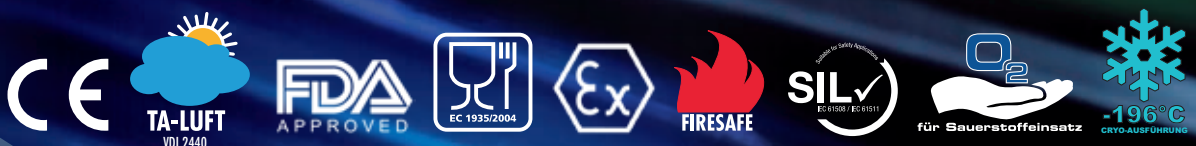

# TECHNICAL FEATURES

Butterfly valve double offset design | type HG

Efficient and safe automation with the interchangeable flange GEFA-MULTITOP

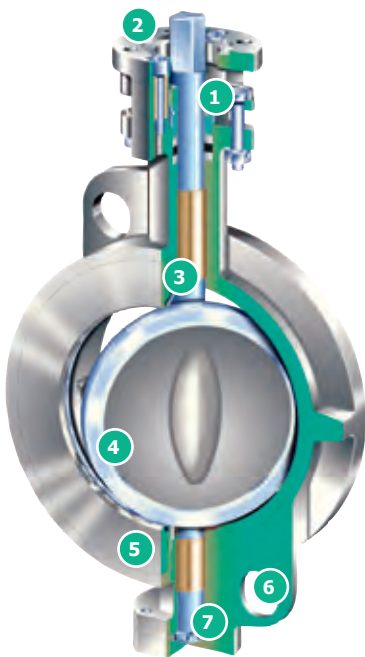

## 1 Automation

- Standard mounting flange according to EN ISO 5211
- Direct actuator mounting without interruption of the stem
- Variable and exchangeable for any actuator size
- Actuator protection against leakage

## 2 Safety (option: TA-Luft)

Stem sealing can be re-tensioned beneath the mounting flange; thus, it can be readjusted without dismantling the actuator.

## 3 Long service life

The insert ring of the body efficiently protects the seat ring from the direct medium flow and prevents wear such as erosion and abrasion.

## 4 Reliability

The double offset design with spherical sealing surface at the disc allows switching with minimum wear and offers the highest level of tightness and low torques at the same time.

## 5 Exact and variable

Face-to-face dimension: EN 558 line 20/25/16  
Option: Design with groove / spring EN 1092, form D

## 6 Precise mounting

Easy mounting due to centring aids for all standard flanges.

## 7 Service-friendly

The axial centring of the stem can be reached easily and is prepared for later service.

## 8 Efficient and safe

The cylindrical screws fix the mounting flange without transferring torques (driving torques).

## 9

The clamping sleeves guarantee a clearance-free connection between the mounting flange and the body and transfer the driving torques.

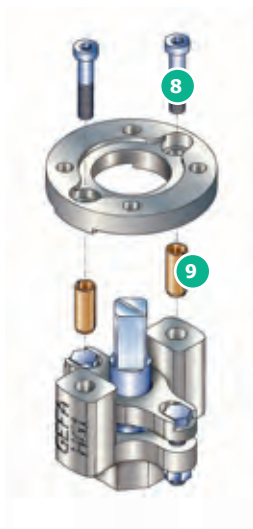

# THE TYPES

Butterfly valve double offset design | type HG



## Type HG 1 DN 50 – DN 600

Double offset valve as wafer type butterfly valve for high pressure and temperature loads

### Wafer style

#### Technical Data

For installation between flanges EN 1092, PN 10/16/25/40, PS 25 ASME CI 150/300, PS25

#### Temperature range

-50 °C to + 450 °C  
Vacuum: up to 1 mbar (abs)

#### Face-to-face dimension

DIN EN 558 line 20  
Optional: line 25 and line 16  
API 609 table 1

#### Mounting flange

DIN EN ISO 5211

#### Test

DIN EN 12266 P10 P11 P12 F20

#### Marking

DIN EN 19, AD 2000

## Type HG 7 DN 50 – DN 600

Double offset valve with lugs for high pressure and temperature loads

### Can be removed from the flange on one side

#### Technical Data

For installation between flanges EN 1092, PN 10/16/25/40, PS 25 ASME CI 150/300, PS25

#### Temperature range

-50 °C to + 450 °C  
Vacuum: up to 1 mbar (abs)

#### Face-to-face dimension

DIN EN 558 line 20  
Optional: line 25 and line 16  
API 609 table 1

#### Mounting flange

DIN EN ISO 5211

#### Test

DIN EN 12266 P10 P11 P12 F20

#### Marking

DIN EN 19, AD 2000

## Type HG 7 ...BK DN 50 – DN 600

Double offset valve with lugs for high pressure and temperature loads

### Can be removed from the flange on both sides

#### Technical Data

For installation between flanges EN 1092, PN 10/16/25/40, PS 25 ASME CI 150/300, PS25

#### Temperature range

-50 °C to + 450 °C  
Vacuum: up to 1 mbar (abs)

#### Face-to-face dimension

DIN EN 558 line 20  
Optional: line 25 and line 16  
API 609 table 1

#### Mounting flange

DIN EN ISO 5211

#### Test

DIN EN 12266 P10 P11 P12 F20

#### Marking

DIN EN 19, AD 2000

## Type HGF DN 50 – DN 600 FireSafe version

Double offset valve for the use in the FireSafe area according to DIN EN ISO 10497, API 607 und BS 6755 Part 2

### Wafer or lug style

#### Technical Data

For installation between flanges EN 1092, PN 10/16/25/40, PS 25 ASME CI 150/300, PS25

#### Temperature range

-50 °C to + 450 °C

#### Face-to-face dimension

DIN EN 558 line 20  
Optional: line 25 and line 16  
API 609 table 1

#### Mounting flange

DIN EN ISO 5211

#### Test

DIN EN 12266 P10 P11 P12 F20

#### Marking

DIN EN 19, AD 2000



**Type HGC**  
DN 50 – DN 600  
**Cryo version**

Double offset valve for the use down to -200 °C with cryogenic stem extension as pressure chamber

**Wafer or lug style**

**Technical Data**

For installation between flanges EN 1092, PN 10/16/25/40, PS 10 ASME CI 150/300, PS25

**Temperature range**  
-200 °C to +200 °C

**Face-to-face dimension**  
DIN EN 558 line 20  
Optional: line 25 and line 16  
API 609 table 1

**Mounting flange**  
DIN EN ISO 5211

**Test**  
DIN EN 12266 P10 P11 P12 F20

**Marking**  
DIN EN 19, AD 2000



**Type HGH**  
DN 50 – DN 600  
**Valve with heating jacket**

Double offset valve with heating jacket with two chambers connections: flange, welding socket, threaded socket

**Technical Data**

For installation between flanges EN 1092, PN 10/16/25/40, PS 25 ASME CI 150/300, PS25

**Temperature range**  
-50 °C to +450 °C

**Face-to-face dimension**  
DIN EN 558 line 20  
Optional: line 25 and line 16  
API 609 table 1

**Mounting flange**  
DIN EN ISO 5211

**Test**  
DIN EN 12266 P10 P11 P12 F20

**Marking**  
DIN EN 19, AD 2000



**Type HGHL**  
DN 50 – DN 600  
**Welded valve**

Double offset valve with double shell for heating without interruption of the pipeline heating.

**Technical Data**

For installation between flanges EN 1092, PN 10/16/25/40, PS 25 ASME CI 150/300, PS25

**Temperature range**  
-50 °C to +450 °C

**Face-to-face dimension**  
according to customer specifications

**Mounting flange**  
DIN EN ISO 5211

**Test**  
DIN EN 12266 P10 P11 P12 F20

**Marking**  
DIN EN 19, AD 2000



**Type HG1 / 7 L**  
DN 50 – DN 600  
**Food**

Double offset valve for the use in the food industry according to the regulation EC1935/2004

**Technical Data**

For installation between flanges EN 1092, PN 10/16/25/40, PS 25 ASME CI 150/300, PS25

**Temperature range**  
-20 °C to +200 °C

Vacuum: up to 1 mbar (abs)  
**Face-to-face dimension**  
DIN EN 558 line 20  
Optional: line 25 and line 16  
API 609 table 1

**Mounting flange**  
DIN EN ISO 5211

**Test**  
DIN EN 12266 P10 P11 P12 F20

**Marking**  
DIN EN 19, AD 2000  
VO (EG) 1935/2004

# DETAILED SOLUTIONS

Butterfly valve double offset design | type HG

## The seat ring system

### Highly flexible with optimised restoring force

If it is installed in the recommended flow direction, the differential pressure efficiently supports the bubble-tight sealing

### Options

- Low temperature seat ring
- Seat ring made of high performance plastics for extreme cases of application

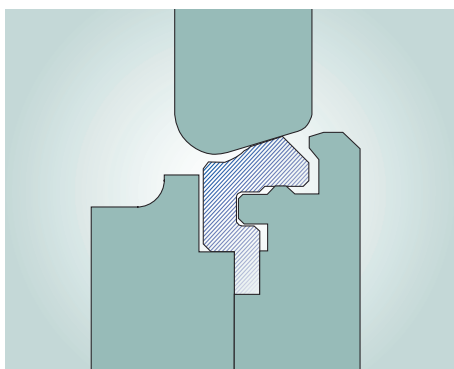

### R-PTFE seat ring

Highly flexible design – chemically almost unlimited resistant. Pressure-resistant due to glass fibre reinforcement even at high temperatures. Tightness EN12266, leakage rate A.

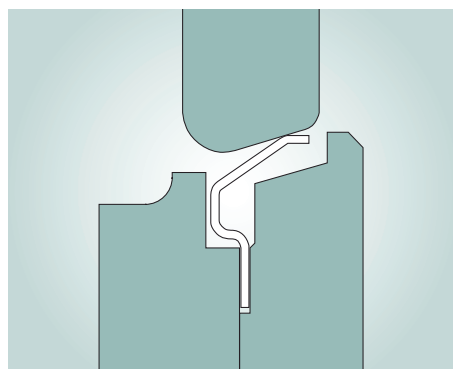

### Metal seat ring

Excellent spring characteristics due to the special form. High temperature-resistant due to the seat ring construction of: 1.4571 nitrated, tightness up to + 450 °C, EN12266, leakage rate B.

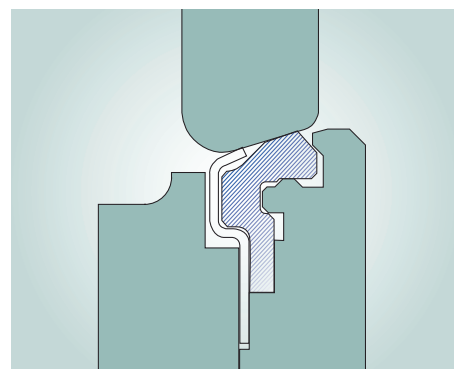

### Firesafe seat ring

Double seat PTFE/1.4571 certified according to EN ISO 10497:2010-06 API607, 6th edition.

## The double offset design

The double offset design allows a reliable, almost wear-free shut-off. Due to the double displacement of the pivot, the valve disc is lifted from the seat at the beginning of the opening movement. The seat is then free from heavy pressure over the whole circumference.

**The 90 ° turning is frictionless at even reduced torques.**

These design characteristics allow an extremely long functional life – even at high switching frequencies. The recommended pressure direction (arrow mark at the body) ensures complete tightness.

The active pressure (differential pressure) of the medium additionally supports the sealing function via the pressing effect of the seat ring against the sealing surface of the disc. The insert ring and the body additionally protect the flexible seat ring efficiently against negative flow influences.

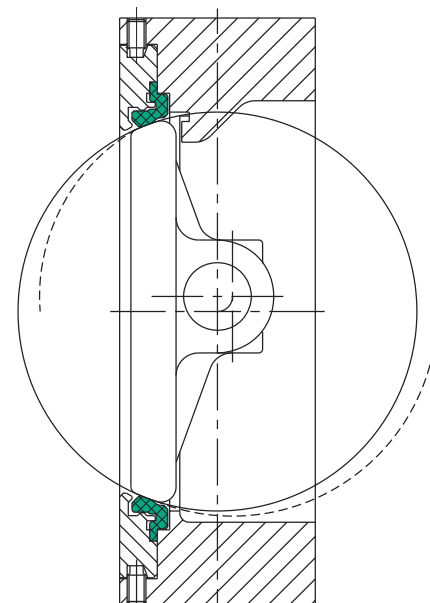

# TECHNICAL DATA

Butterfly valve double offset design | type HG

## Pressure and temperature range diagram

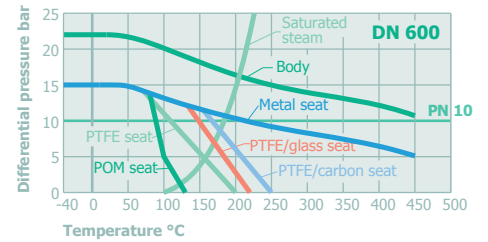
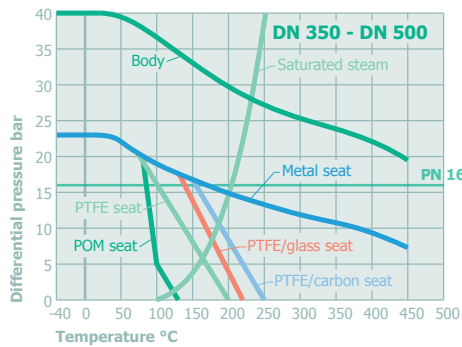
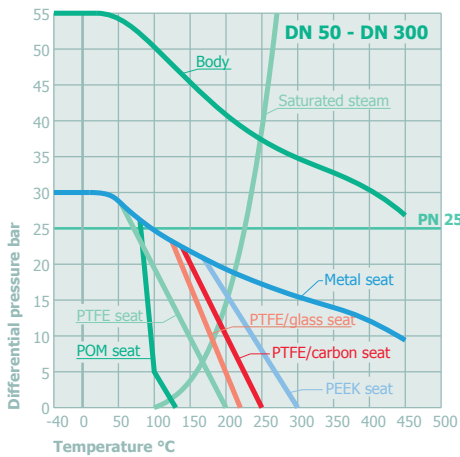

### Control range

20° – 60° opening angle

### Vacuum-tight

up to 1 mbar (a)

### Flange surfaces

according to DIN EN 1092-1 form B1

The pressure and temperature range diagram shows the application limits of the different seat ring materials. These limits apply to the intended use. Process variables and characteristics of the medium can influence the values of the diagram. Temperatures below -50 °C upon request.

Nominal size	Nominal pressure	max. operating pressure
DN 50 – DN 300	PN 10/16/25/40 ANSI 150/300	25 bar
DN 350 – DN 500	PN 10/16/25 ANSI 150	16 bar
DN 600 – DN 1000	PN 10/16 ANSI 150	10 bar

The maximum operating pressure depends on the operating temperature.

## Available materials

Position	Designation	Material							
		≤ DN 300 ≥ DN 350	HG 4466 TG HG 4444 TG	HG 6666 TG	HG 4435 M HG 4444 M	HG 6635 M	HG 4435 HM HG 4444 HM	HG 6635 HM	HGF 4466 TM
	<b>max. operating temp.</b>	+220 °C	+220 °C	+220 °C	+220 °C	+450 °C	+450 °C	+200 °C	+200 °C
1	Body	1.0619	1.4408	1.0619	1.4408	1.0619	1.4408	1.0619	1.4408
2	Valve disc ≤ DN 300 ≥ DN 350	1.4408 1.0619/ nickel-plated	1.4408 1.4408	1.4408/ nitrated 1.0619/ nickel-plated	1.4408/ nitrated 1.4408/ nitrated	1.4408/ nitrated 1.0619/ nickel-plated	1.4408/ nitrated 1.4408/ nitrated	1.4408/ nitrated 1.0619/ nickel-plated	1.4408 1.4408
3	Welle	1.4571	1.4571	1.4571	1.4571	1.4571	1.4571	1.4571	1.4571
4*	Seat ring	PTFE/Glas	PTFE/Glas	1.4571/ nitrated/ Graphite**	1.4571/ nitrated/ Graphite**	1.4571/ nitrated/ Graphite**	1.4571/ nitrated/ Graphite**	PTFE/1.4571/ nitrated+ Graphite	PTFE/1.4571/ nitrated+ Graphite
5	Bearing bush	1.4401/PTFE	1.4401/PTFE	1.4401/PTFE	1.4401/PTFE	1.4571/nitrated	1.4571/nitrated	1.4571/nitrated	1.4571/nitrated
6*	Package	PTFE	PTFE	PTFE	PTFE	Graphite	Graphite	Graphite	Graphite
7	Insert ring	C-steel	1.4571	C-steel	1.4571	C-steel	1.4571	1.4571	1.4571

\* Spare part/wear part, \*\*Option: 1.4571/nitrated/PTFE